

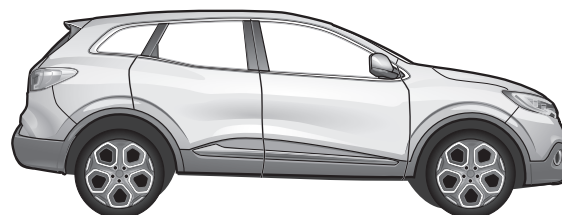

Espace V

04/15→



Kadjar

06/15→

PL

Zestaw elektryczny do haka holowniczego / 7-biegunowy / 12 Volt / ISO 1724

Instrukcja montażu

SK

Elektrosada pre ťažné zariadenie / 7-pol / 12 Volt / ISO 1724

Návod na použitie

GB

Electric wiring kit for towbars / 7-pin / 12 Volt / ISO 1724

Fitting instructions

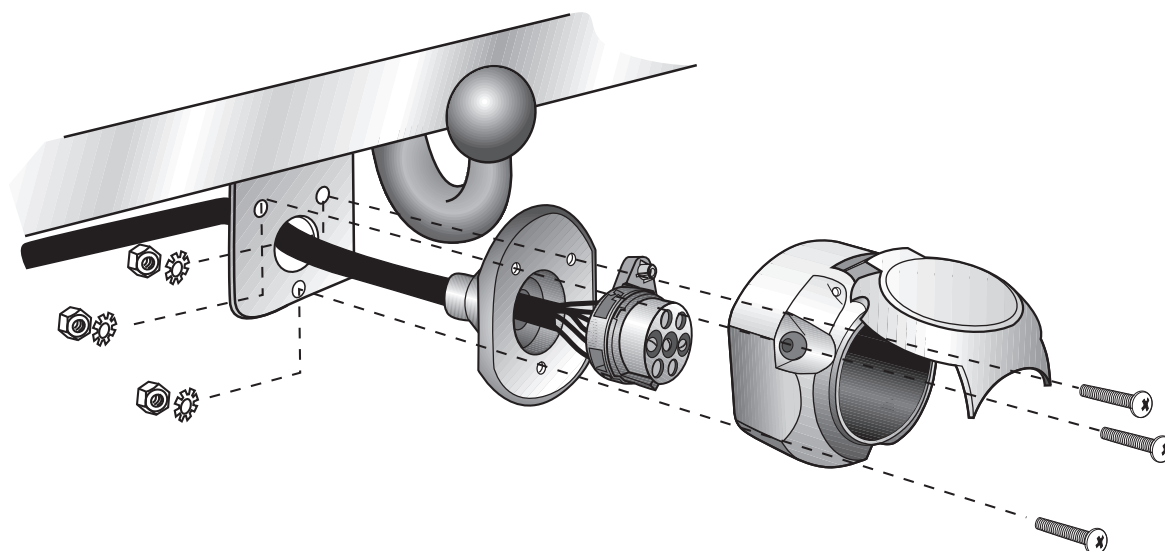

UWAGA!

PL

Przed rozpoczęciem montażu wiazki elektrycznej należy dokładnie zapoznać się z dołączoną instrukcją. Po zamontowaniu wiazki do samochodu instrukcje montażu należy dołączyć do dokumentacji samochodu. Montaż wiazki elektrycznej musi być przeprowadzony przez specjalistyczny warsztat samochodowy. Montaż wiazki przez osoby niewykwalifikowane, lub dokonywanie zmian w połączeniach wiazki (niezgodnych z dołączoną instrukcją) powoduje utratę gwarancji. Zamiana elektronicznych podzespołów w wiazce jest zabroniona. W przypadku jazdy bez przyczepy reduktory nie mogą pozostawać w gnieździe.

Zmiany w instrukcji montażu wiazki dotyczące konstrukcji, wyposażenia kolorów, błędów mogą się zdarzyć. W przypadku gdy przyczepa nie jest wyposażona w światło przeciwmgielne, należy je zamontować.

Za wszystkie zmiany techniczne i elektroniczne dokonane w samochodzie lub w przyczepie po montażu wiazki i mające bezpośredni wpływ na jej działanie nie bierzemy odpowiedzialności.

Między modulem sterującym w wiazce elektrycznej a modulem sterującym samochodem nie ma bezpośredniej komunikacji. W przypadku gdy modul sterujący samochodem generuje komunikat o błędach, które są bezpośrednie lub pośrednio spowodowane przez modul wiazki elektrycznej, należy ten modul odłączyć i przeprowadzić test ponownie.

POZOR!

SK

Montáž tejto elektrosady musí byť prevedená v špecializovanom servise alebo primerane kvalifikovanou osobou. Pred začatím montáže je nutné dôkladne si prečítať návod na použitie. Po ukončení montáže je potrebné tento návod odložiť ku servisným dokumentom vozidla.

Pri neodbornej montáži alebo zmene elektrosady, prípadne zmene existujúcich súčiastok, zanika akýkoľvek nárok na záruku. Pri jazde bez príviesu je nutné odpojiť adapter zo zásuvky (ak je tento prevádzka). Zmeny týkajúce sa konštrukcie, vybavenia, farieb, ako aj omyly sú vyhradené. Všetky špecifikácie a ilustrácie sú nezáväzná.

Ak prívies nie je vybavený hmlovým svetlom, je potrebné ho dodatočne namontovať.

Za technické zmeny, prípadne zmeny elektroniky, ktoré boli uskutočnené výrobcami vozidla po uvedení elektrosady do prevádzky a ktoré vedú k chybným funkciám zásuvky alebo prídavných zariadení, nepreberáme žiadne záruky.

Modul príviesu nie je schopný komunikovať s diagnostickým zariadením. V prípade, že testovacie mechanizmy generujú chybný protokol pri diagnostike, súvisiaci či už priamo alebo nepriamo s prevádzkou príviesu, je nutné odpojiť modul príviesu od elektrosady a opakovane vykonať diagnostiku.

IMPORTANT!

GB

Installation of the towing electrics kit must be undertaken by a specialist workshop or an appropriately qualified person. Before starting work, you must read the installation instructions through completely. After installing the towing electrics kit, the installation instructions should be kept with the vehicle service documentation.

All claims under the guarantee will lapse in case of improper use or modification of the towing electrics kit or any of its component parts. When driving without a trailer or load carrier, any adapter installed must be removed from the electrical socket. We reserve the right to alter the design, content or colour. We accept no liability for any errors in these instructions. All details and illustrations are non-binding.

In case of missing a rear fog lamp on the trailer, it should be retrofitted.

We accept no responsibility and give no guarantee for technical and electrical modifications made after the initial operation of the towing electrics kit by the vehicle manufacturer and which may lead, for example to malfunction of the trailer socket or its peripheries.

The trailer module is not diagnostics-capable. If the manufacturer's diagnostics processes or software-supported test mechanisms generate error reports directly or indirectly linked with trailer operation, the trailer module must be disconnected from the leads to the trailer socket and a new diagnostic process initiated.

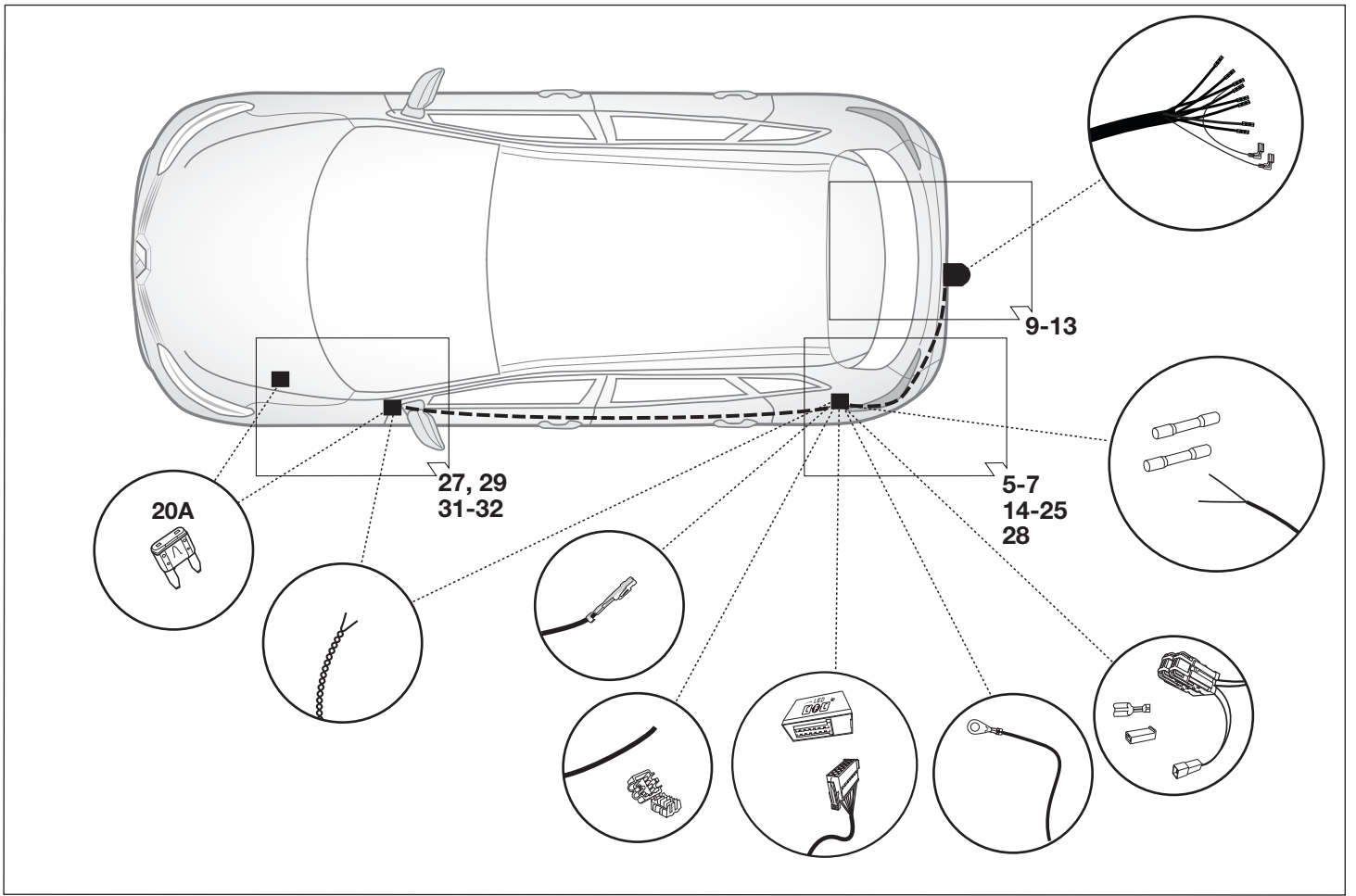
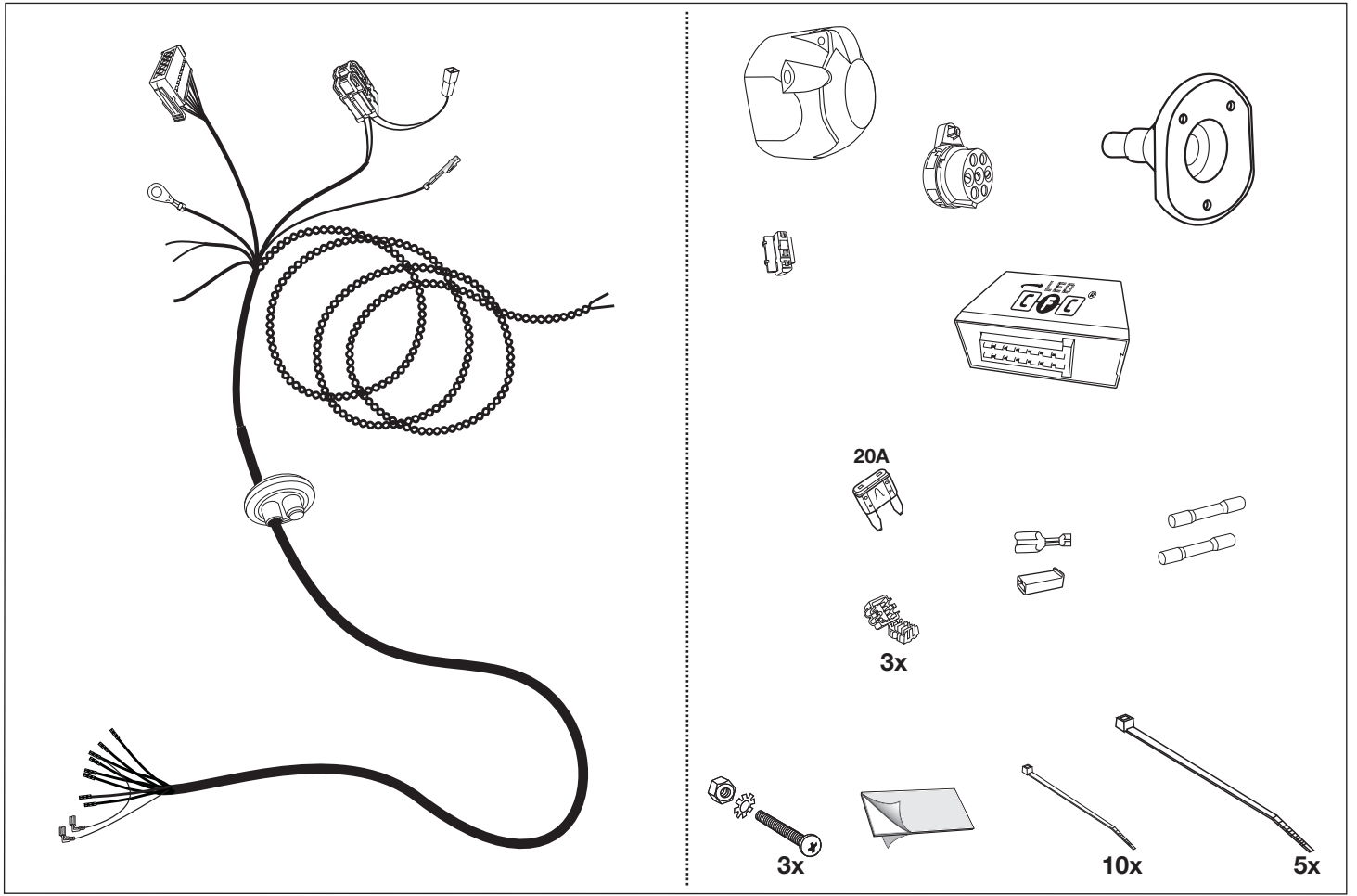

Narzędzia - Nastroje - Tools

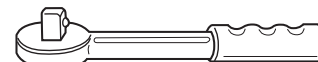
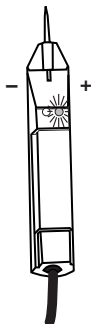
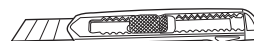
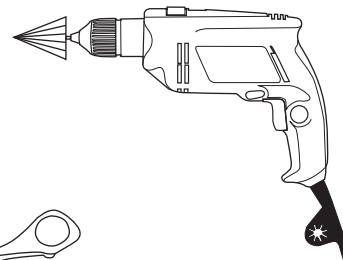
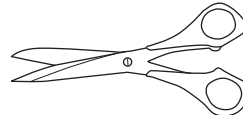
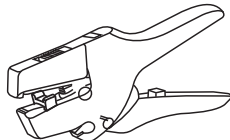
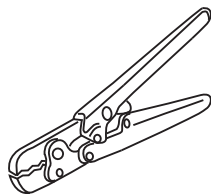
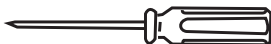
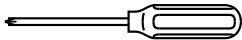
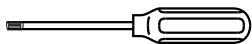

UWAGA!

(PL)

Wydajność układu chłodzenia w zależności od możliwości musi być zwiększona w przypadku zamontowania dodatkowego wyposażenia (hakolowniczy). Proszę koniecznie zwrócić uwagę na zalecenia producenta samochodu !!

POZOR!

(SK)

Vykon chladica vozidla musi byt pri doplneni vybavy o tazne zariadenie podla možnosti zvseny !!
Prosime bezpodmienečne dbat na pokyny vyrobcu !!

ATTENTION!

(GB)

The vehicle's cooling capacity may have to be increased when retrofitting a trailer coupling!
You must observe the manufacturer's instructions!!

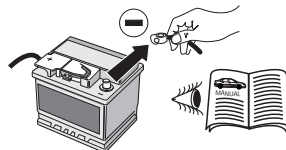

UWAGA!

(PL)

Aby zapobiec zbyt dużym błędom w elektronice samochodu, należy **przed rozpoczęciem montażu** wiazki odłączyć клемę (-) MINUS od akumulatora!

W Przypadku nieodłączenia клемy szczególnie przy montażu modułu CFC (CAN Bus) może nastąpić uszkodzenie tego modułu w wiazce jak również uszkodzenie modułu sterującego w samochodzie!

Dla tego prosimy przestrzegać instrukcji producenta przy odłączaniu i załączaniu клемy akumulatora!

POZOR!

(SK)

Aby sa zabranilo zbyt veľkym chybam v palubnej sieti, **musi** byt odpojena akumulatorova svorka na negativny (minus) pol este **pred zacatim montaze!**

Obzvlast pri pracach a pripojeniach na CAN-datovej zbernici moze dojst pri neodpojenej akumulatorovej svorke k poskodeniu modulu privesu, ako aj k poskodeniu palubneho modulu vozidla!

Prosime dodrziavat pokyny vyrobcu pri odpojeni a pripojeni akumulatora!

ATTENTION!

(GB)

In order to avoid malfunctions and damage to the vehicle's electrical system, the earth terminal **must be disconnected** from the vehicle's battery **before starting work!**

Both the trailer module and the vehicle's control unit for the electrical system can be damaged during work on the CAN data bus connections if the battery is not disconnected!

Please pay attention to the manufacturer's instructions when disconnecting and reconnecting the vehicle's battery!

Espace

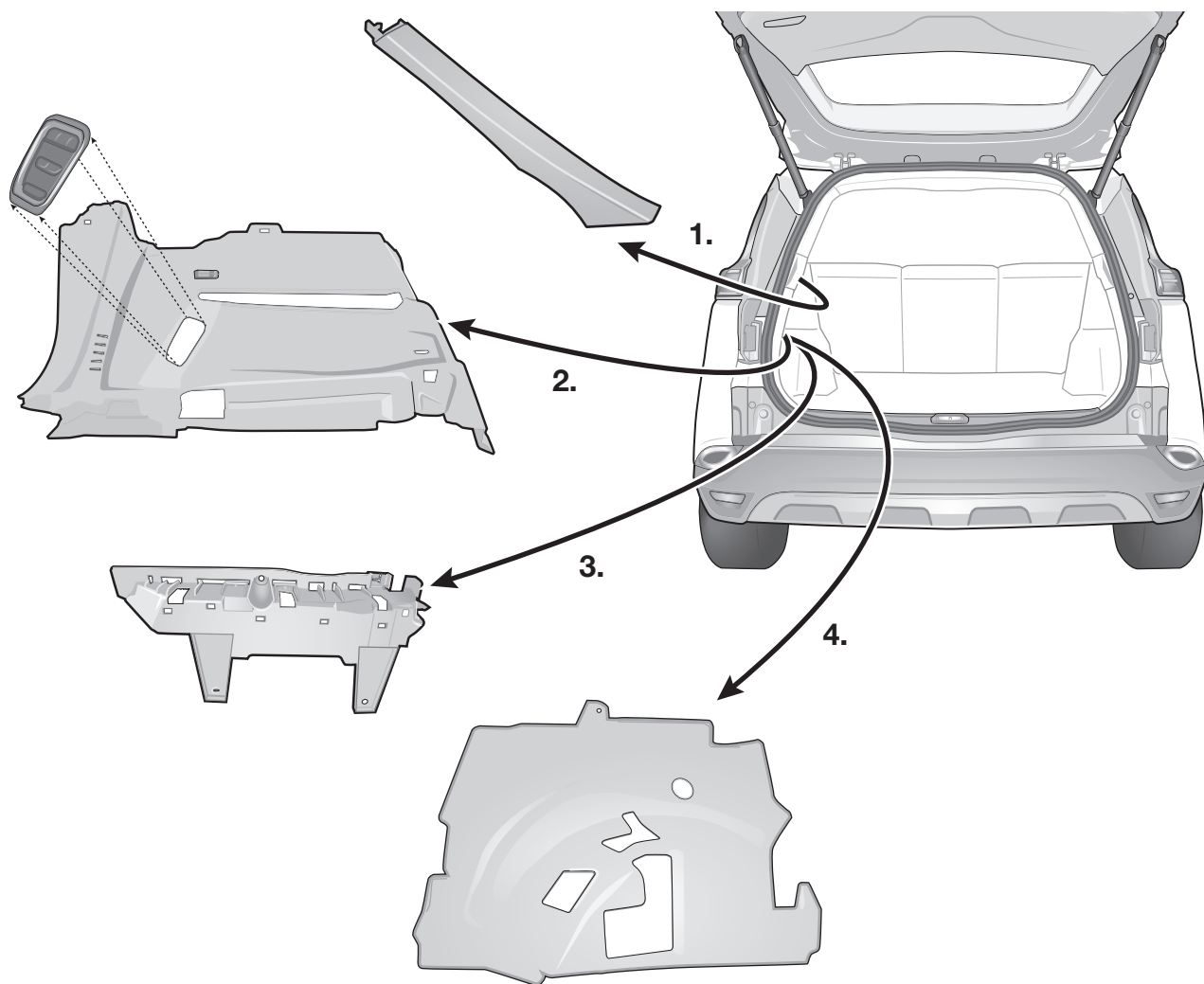
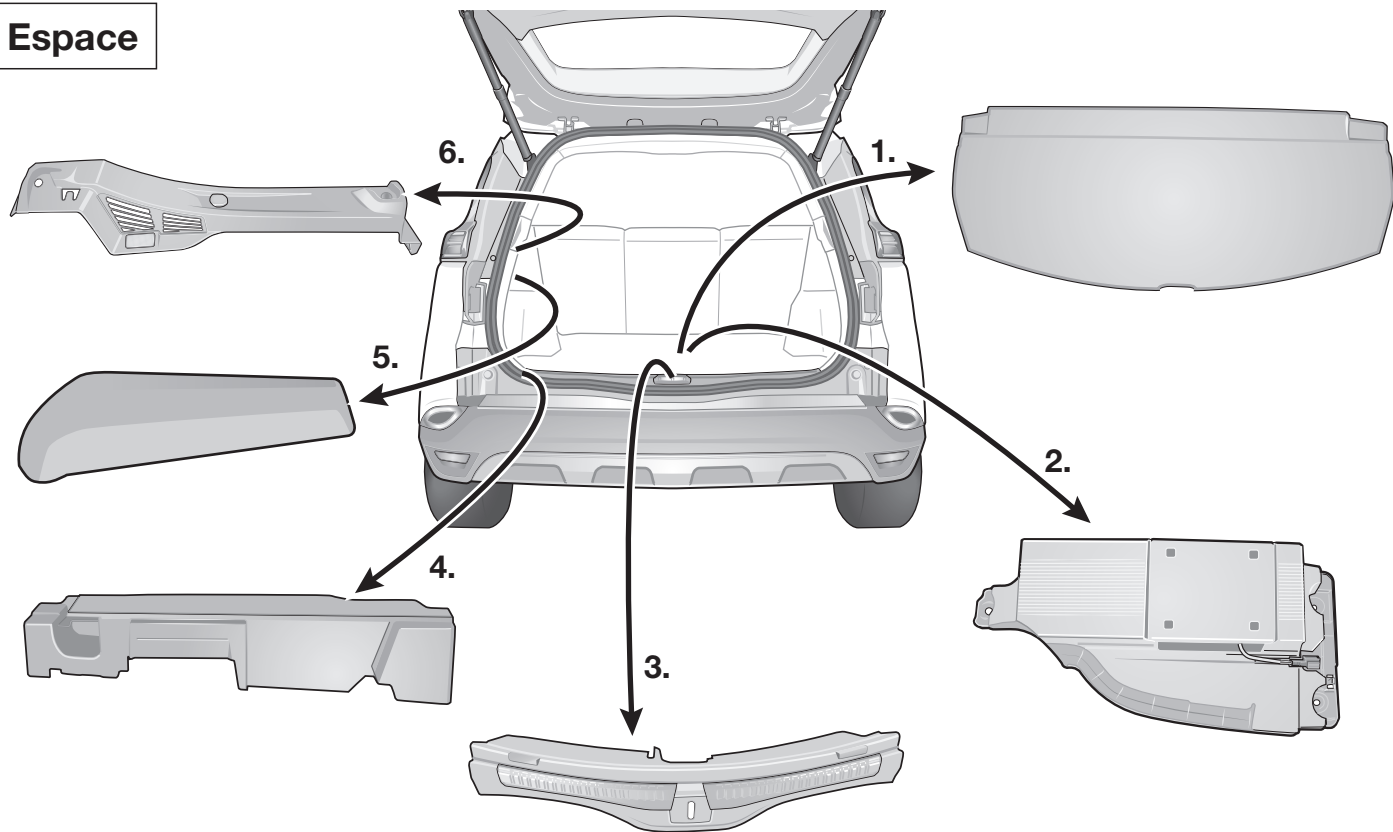

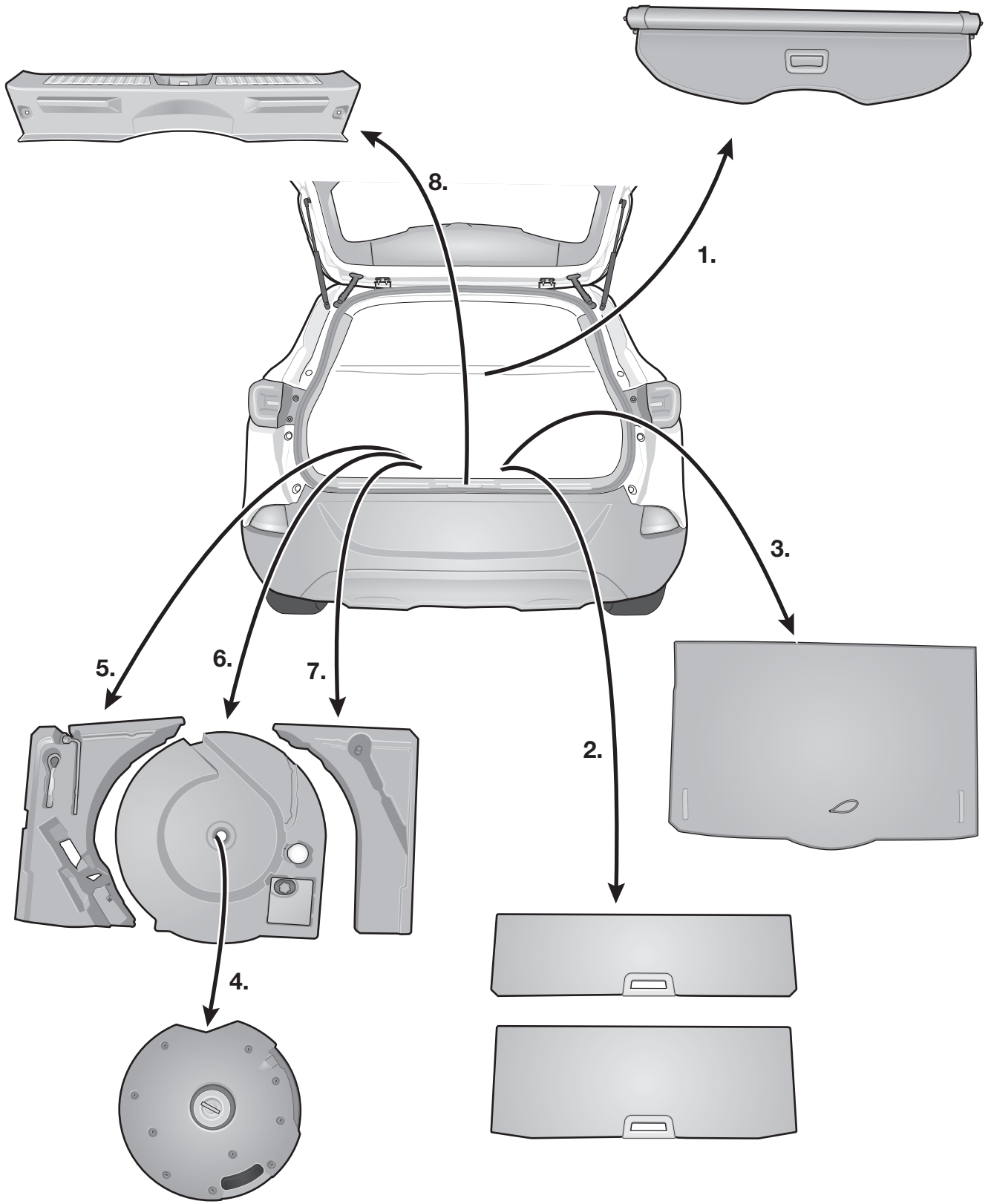

Kadjar

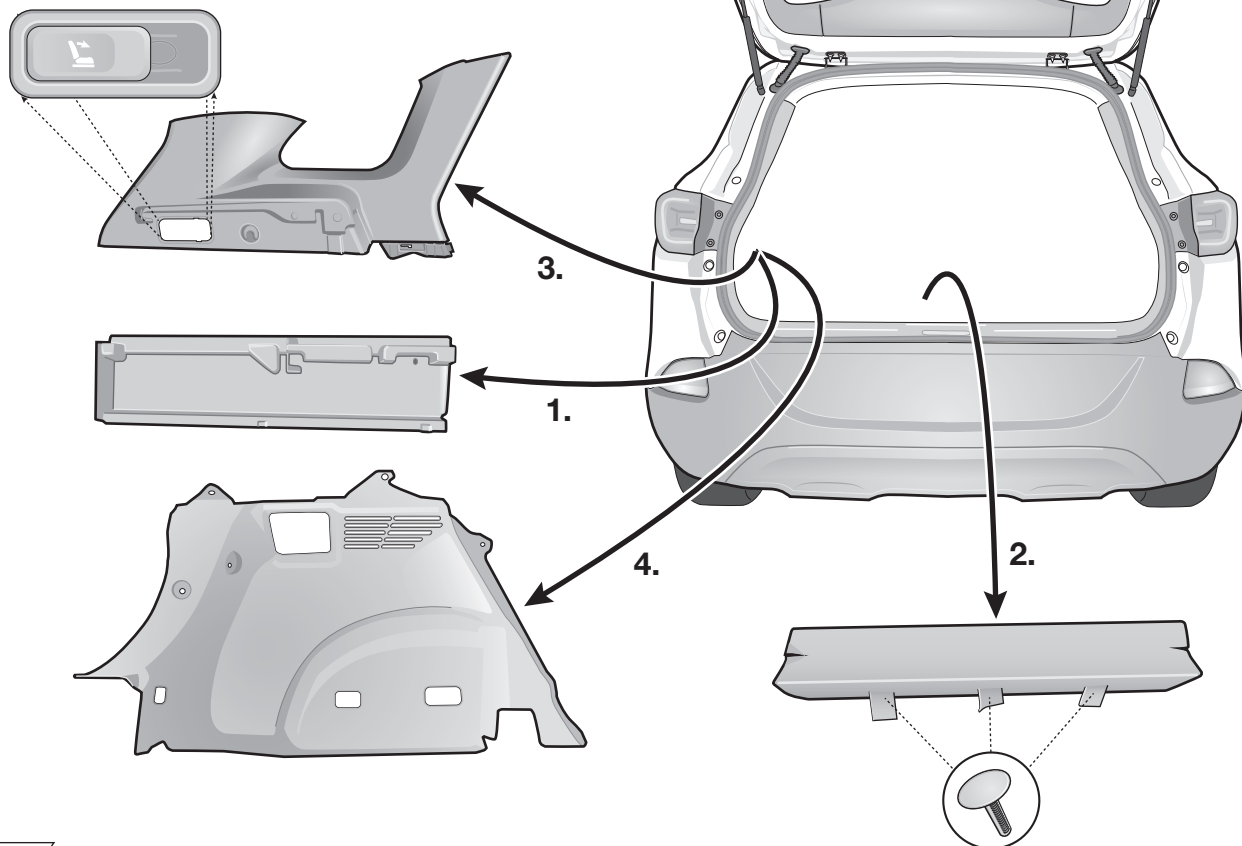

4

Espace Opcja 1

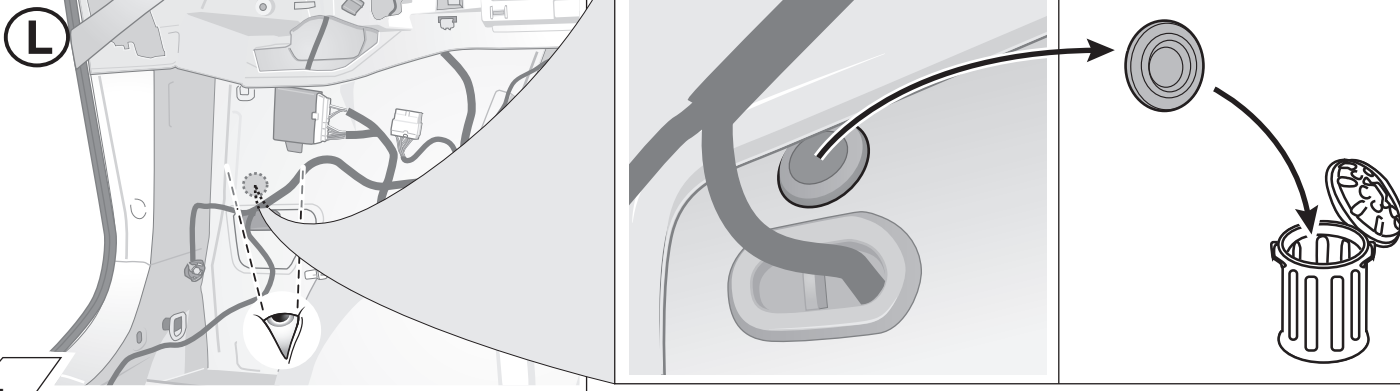

5

Espace Opcja 2

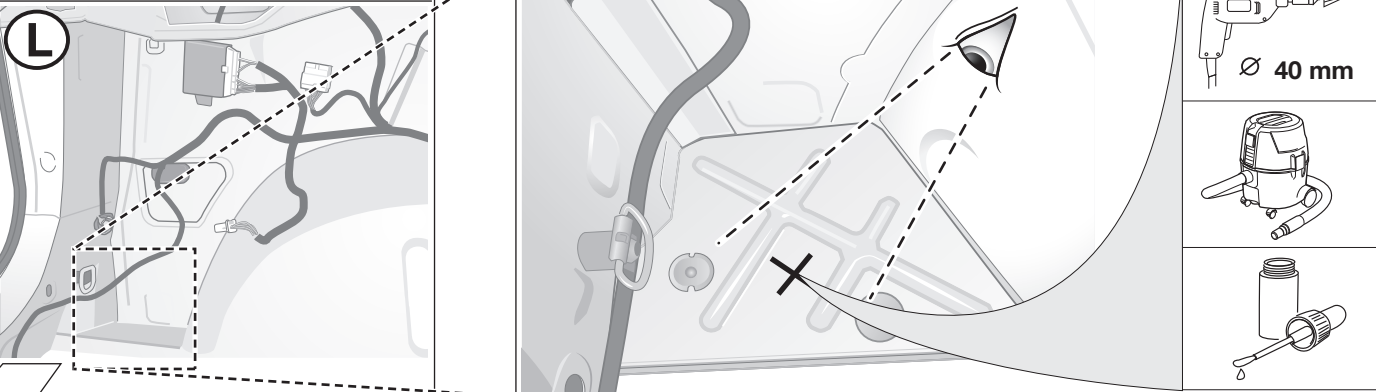

6

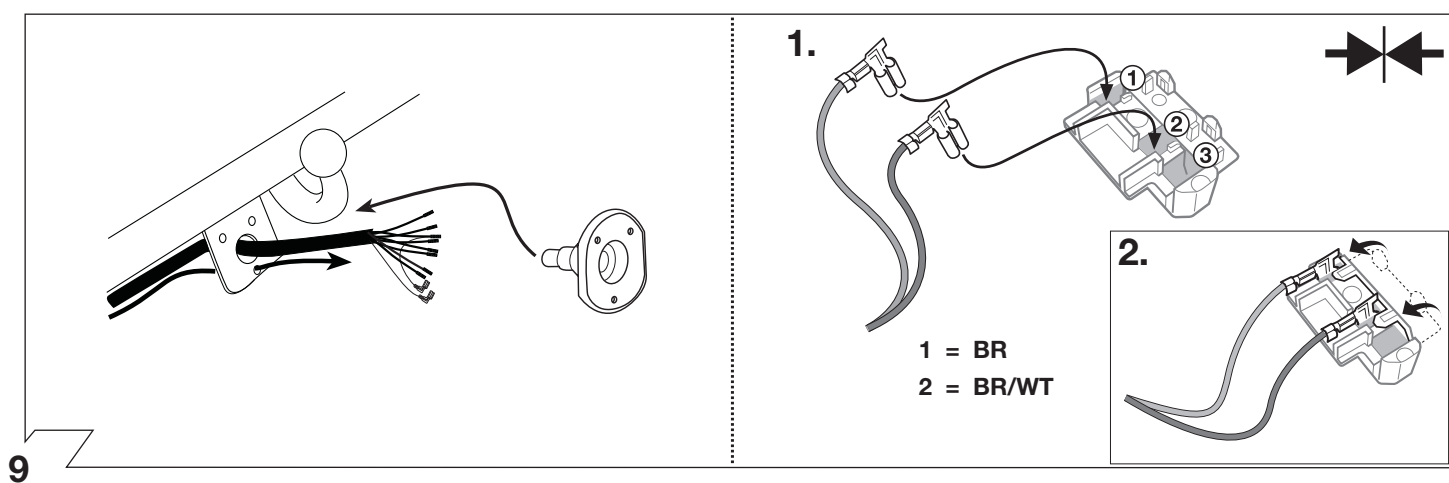
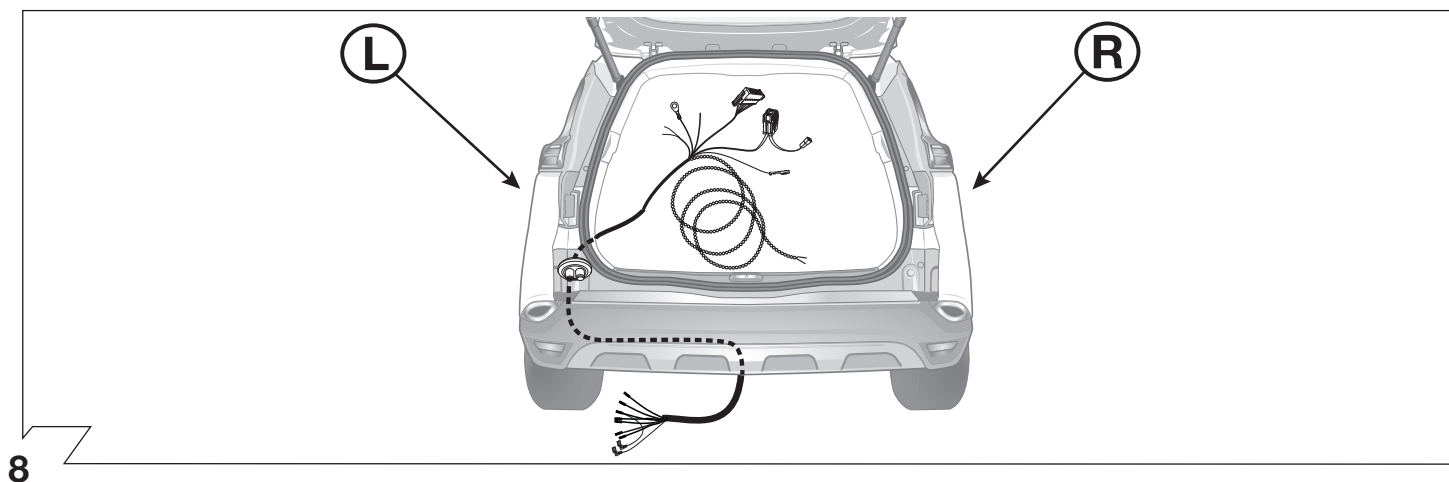
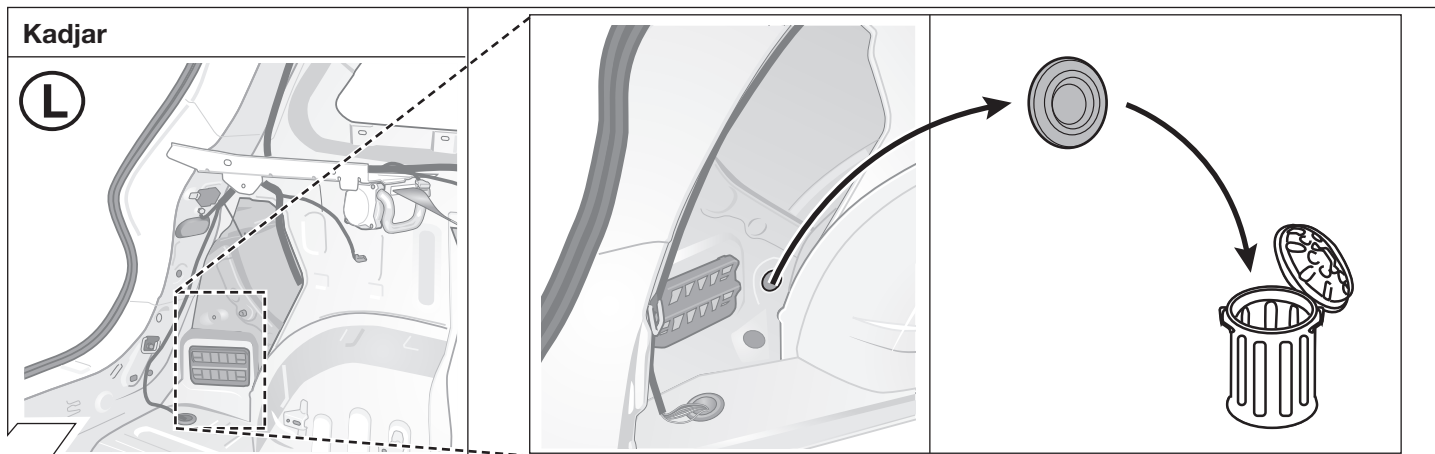

10

	(GB)	(D)	(E)	(F)	(I)	(P)	(NL)	(DK)	(N)	(S)	(FIN)	(CZ)	(H)	(PL)
BK	Black	Schwarz	Negro	Noir	Nero	Preto	Zwart	Sort	Svart	Svart	Musta	Černá	Fekete	Czarny
RD	Red	Rot	Rojo	Rouge	Rosso	Vermelho	Rood	Rød	Rød	Röd	Punainen	Červená	Piros	Czerwony
GN	Green	Grün	Verde	Vert	Verde	Verde	Groen	Grøn	Grønt	Grön	Vihreä	Zelená	Zöld	Zielony
OR	Orange	Orange	Naranja	Orange	Arancione	Laranja	Oranje	Orange	Orange	Orange	Oranssi	Oranzová	Narancs	Pomarańczowy
VT	Violet	Violett	Violeta	Violet	Viola	Violeta	Violet	Violet	Fiolett	Violett	Violetti	Fialová	Ibolya	Fioletowy
PK	Pink	Pink	Pink	Rose	Rosa	Cor-de-Rosa	Paars	Pink	Pink	Rosa	Pinkki	Růžová	Rózsaszín	Różowy
BL	Blue	Blau	Azul	Bleu	Blu	Azul	Blauw	Blå	Blått	Blå	Sininen	Modrá	Kék	Niebieski
YL	Yellow	Gelb	Amarillo	Jaune	Giallo	Amarelo	Geel	Gul	Gult	Gul	Keltainen	Zlutá	Sárga	Żółty
WT	White	Weiss	Blanco	Blanc	Bianco	Branco	Wit	Hvid	Hvitt	Vit	Valkoinen	Bílá	Fehér	Biały
BR	Brown	Braun	Marrón	Brun	Marrone	Marrom	Bruin	Brun	Brunt	Brun	Ruskea	Hnědá	Barna	Brazowy
GY	Grey	Grau	Gris	Gris	Grigio	Cinzeno	Grijs	Grå	Grått	Grå	Harmaa	Sedá	Szürke	Szary

ISO 1724	Podłączenie gniazda / Maksymalne obciążenie na wyjściu Obloženie zasuvky/Maximálny výkon na výstupe Socket Configuration/Maximum power output		
	1/L	BK/WT	21W
	2	WT	42W
	3/31	BR	XXXX
	4/R	BK/GN	21W
	5/58-R	GY/RD	52W
	6/54	BK/RD	63W
	7/58-L	GY/BK	52W
	8	BK	XXXX

11

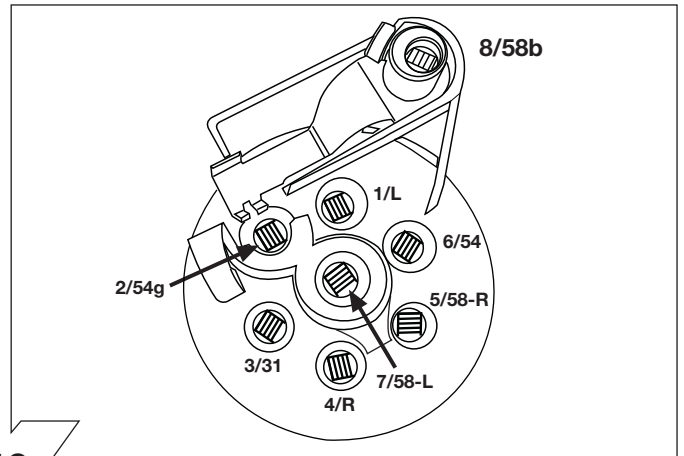

12

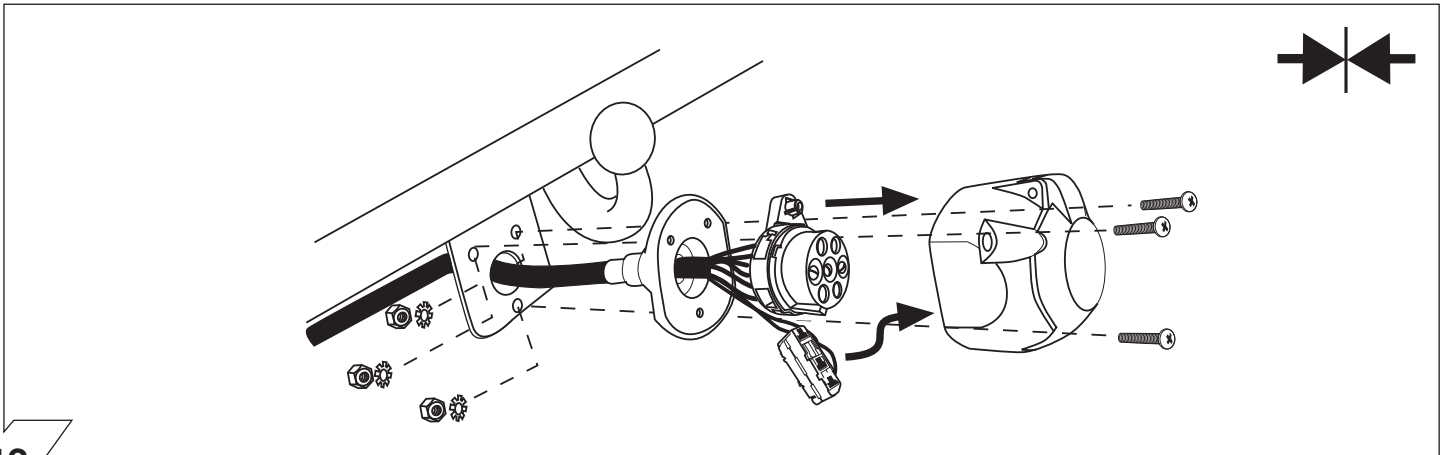

13

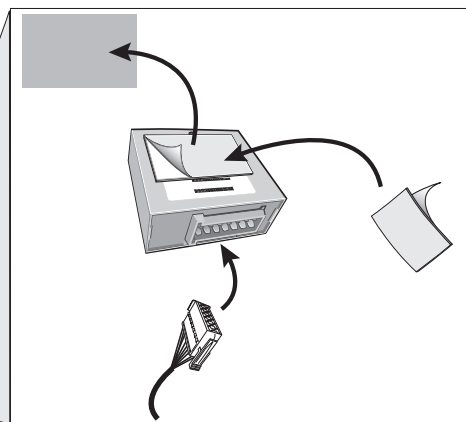
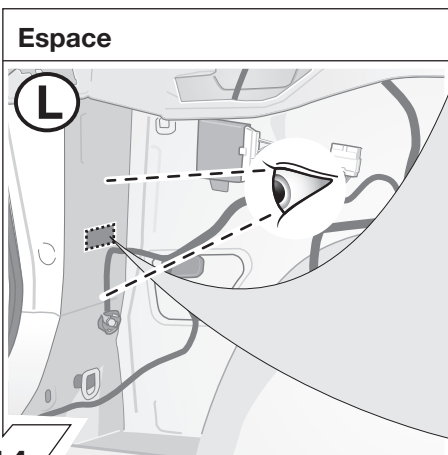

Uwaga!
Zwrócić szczególną uwagę pokazane czynności na obrazku 1

Dôležitě!
Dbat na pokyny z obrazku 1!

Important!
Please note informations in picture 1!

14

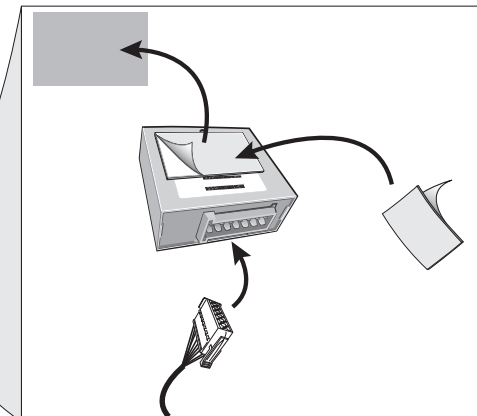
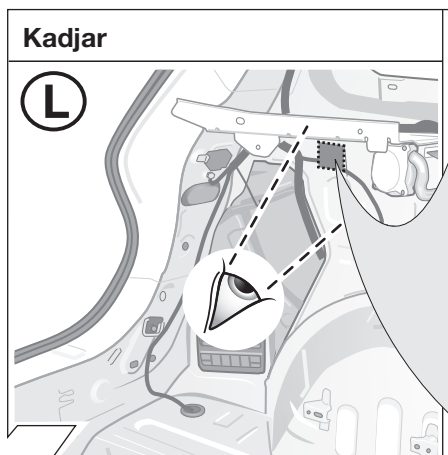

Uwaga!
Zwrócić szczególną uwagę pokazane czynności na obrazku 1

Dôležitě!
Dbat na pokyny z obrazku 1!

Important!
Please note informations in picture 1!

15

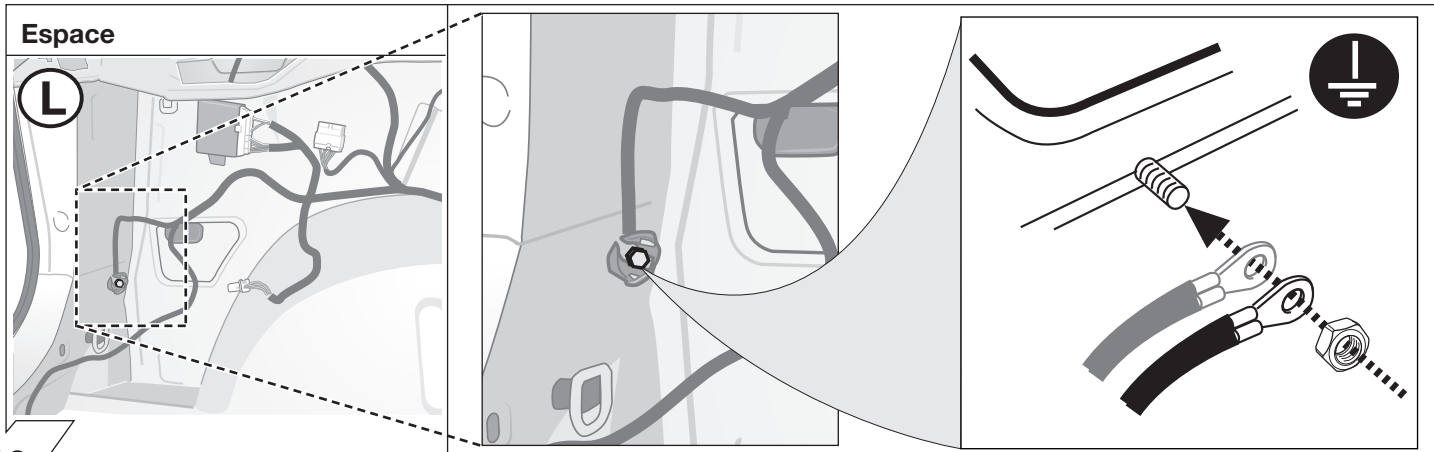

16

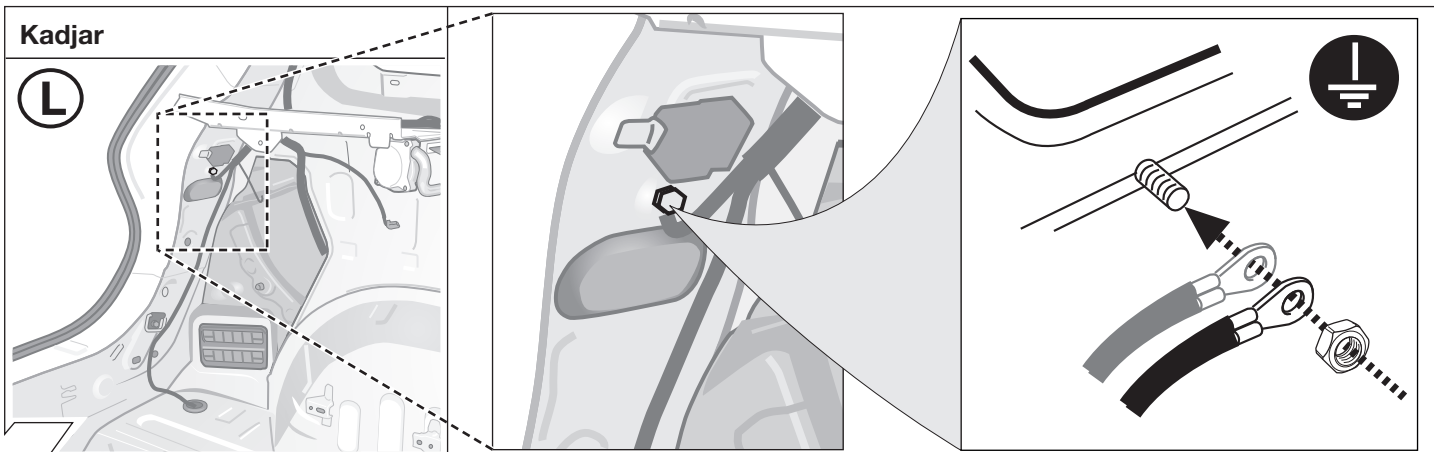

17

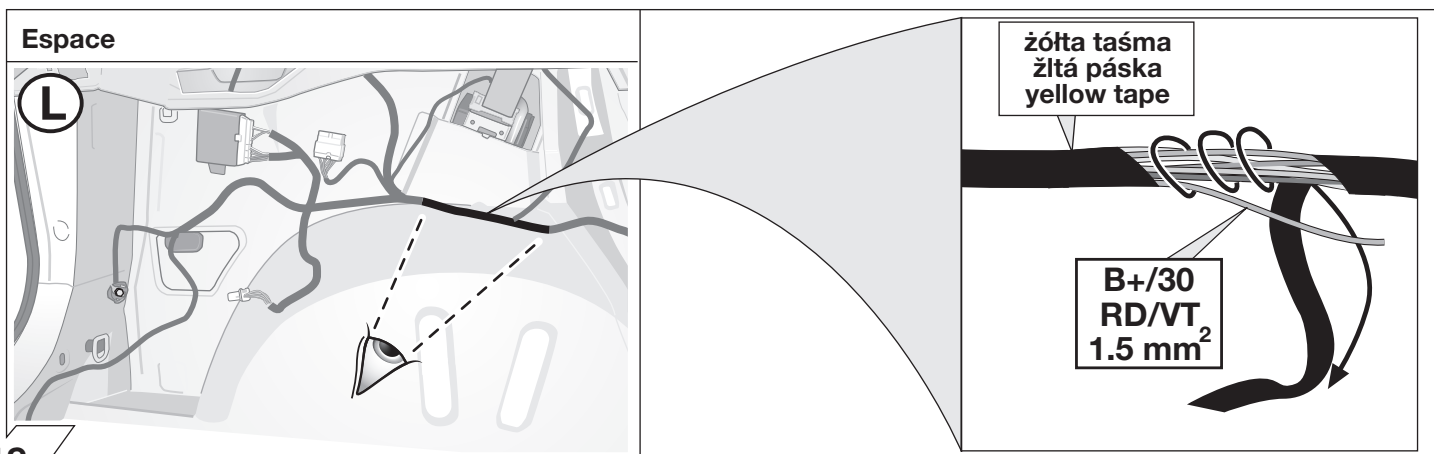

18

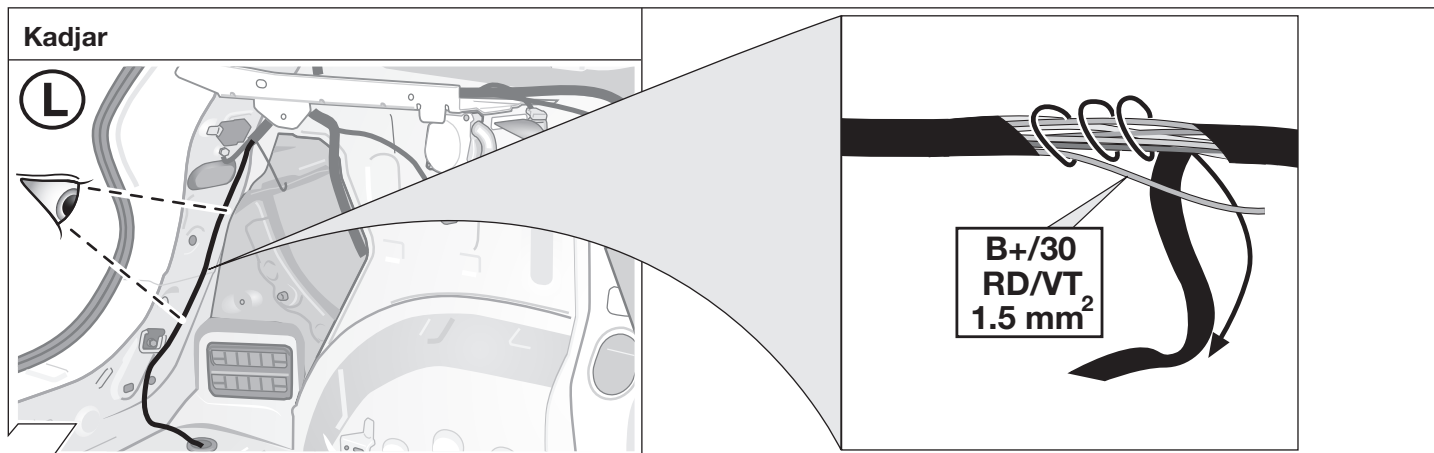

19

Uwaga!
 Zwrocic szczególna uwage pokazane czynnosci na obrazku 1!
 Dôlezité!
 Dbat na pokyny z obrazku 1!
 Important!
 Please note informations in picture 1!

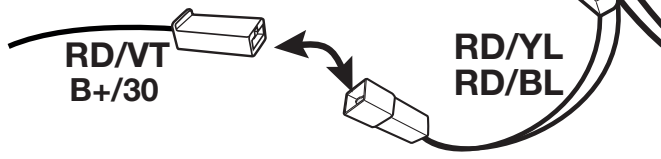
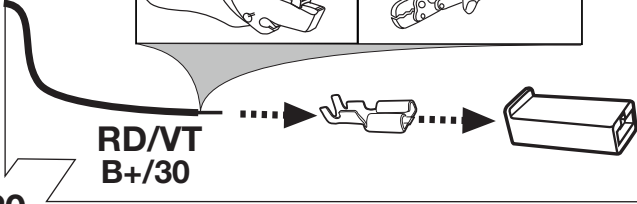
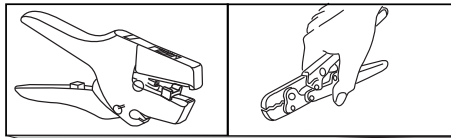

20

Espace

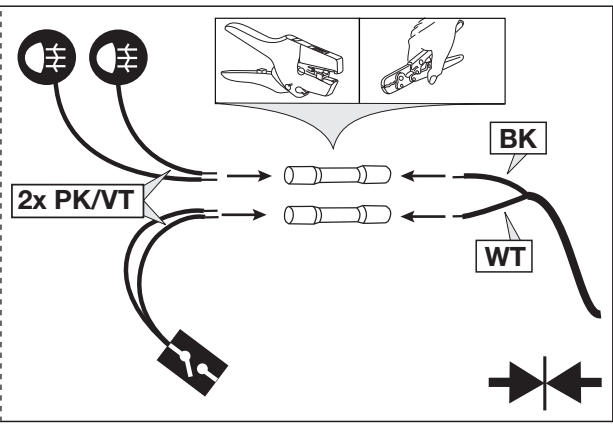
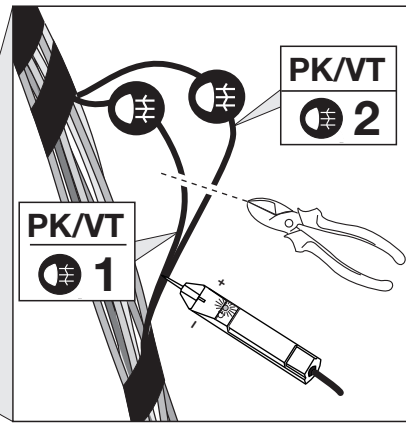
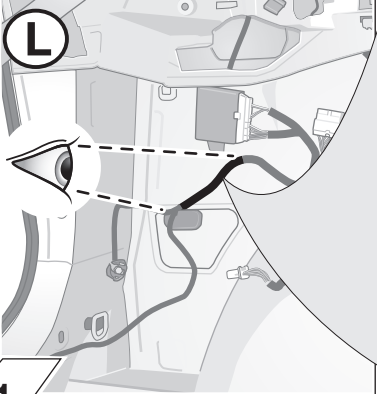

21

Espace

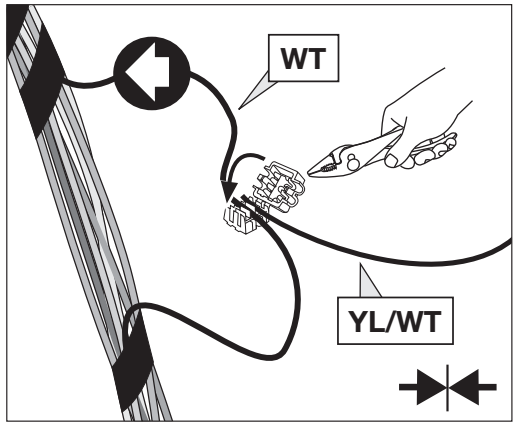
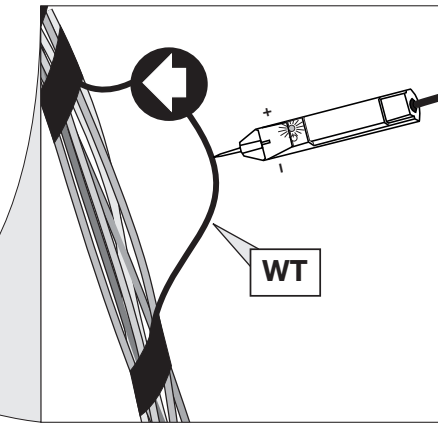
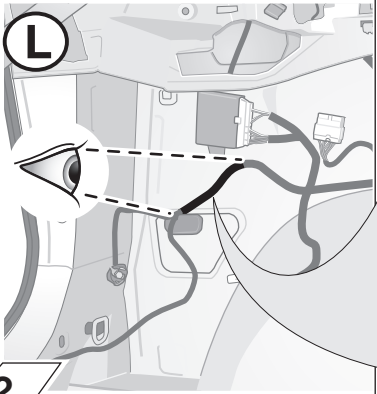

22

Kadjar

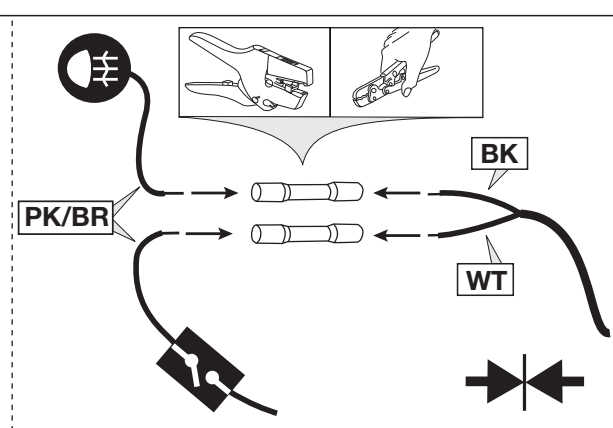
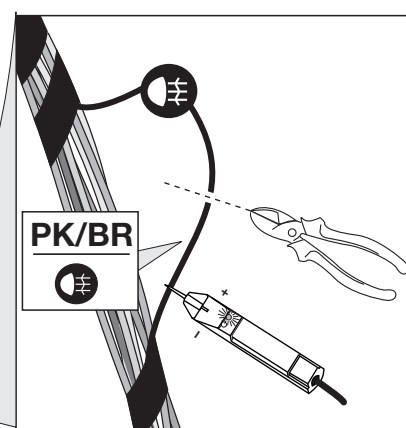
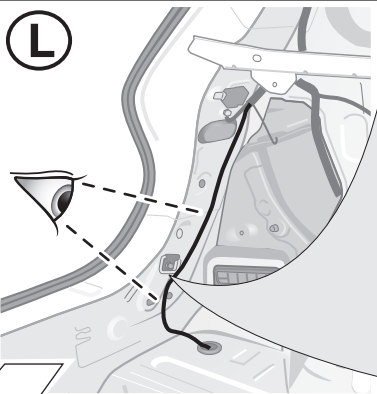

23

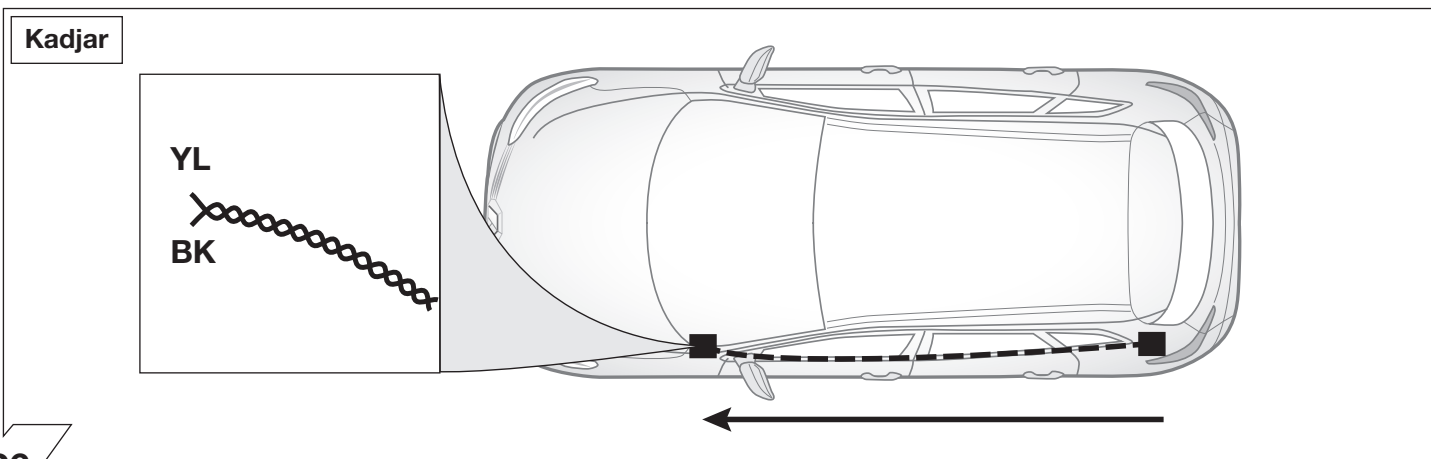
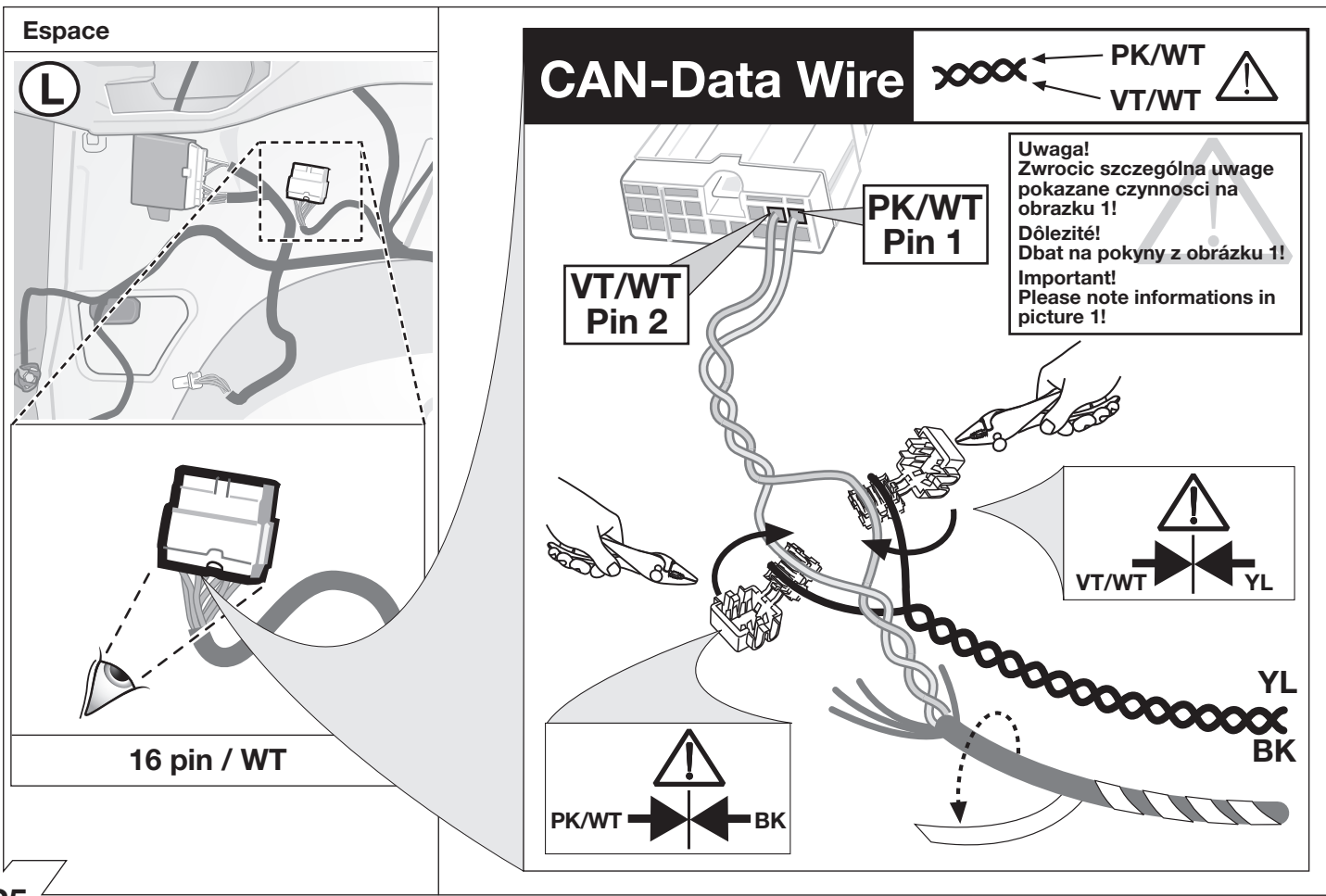
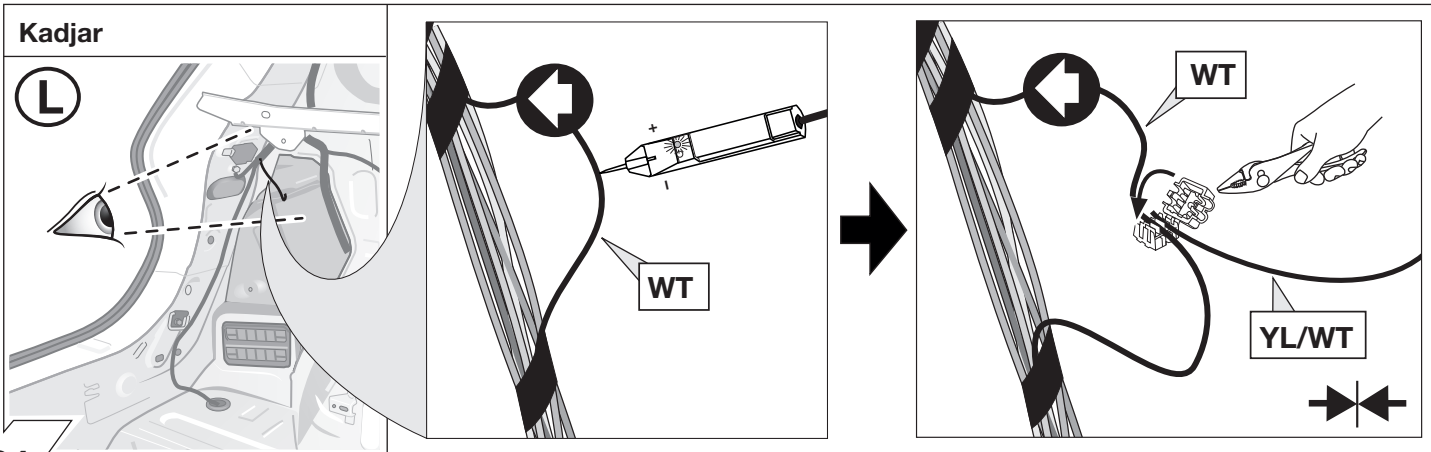

Kadjar

L

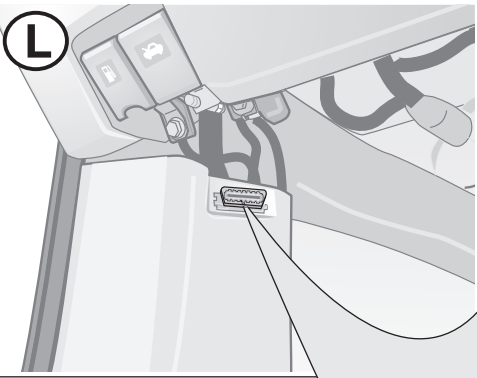

OBD



Uwaga!
Zwrócić szczególną uwagę
pokazane czynności na
obrazku 1!
Dôležitě!
Dbat na pokyny z obrazku 1!
Important!
Please note informations in
picture 1!

CAN-Data Wire

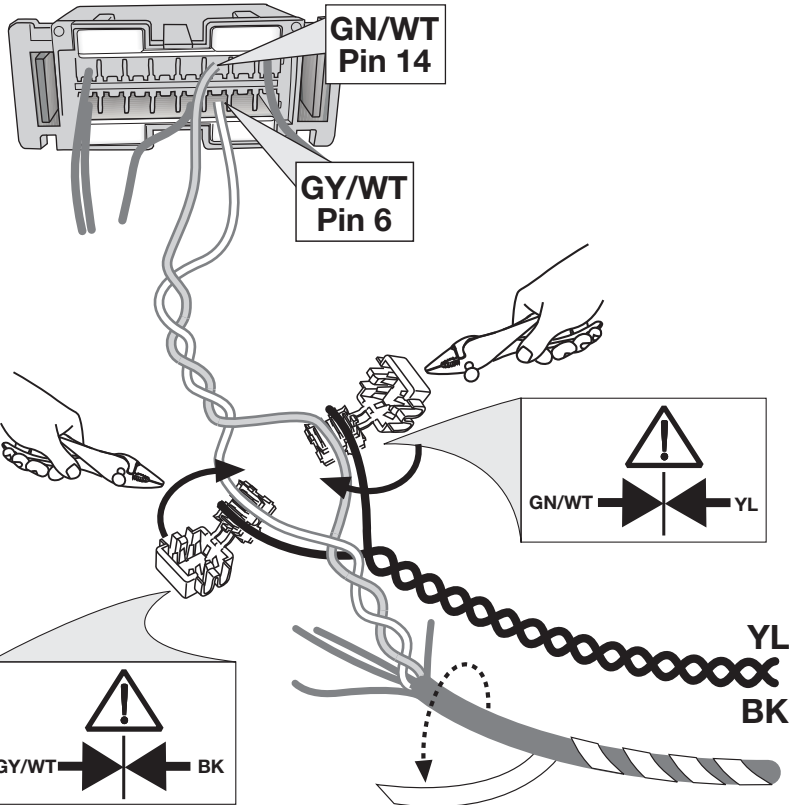

27

Espace



Samochody z czujnikami parkowania montowanymi fabrycznie!
Vozidla so seriovno montovanym parkovacim senzorom
Vehicles with Factory-Fitted PDC-System!



L

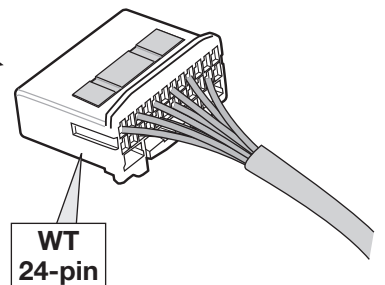
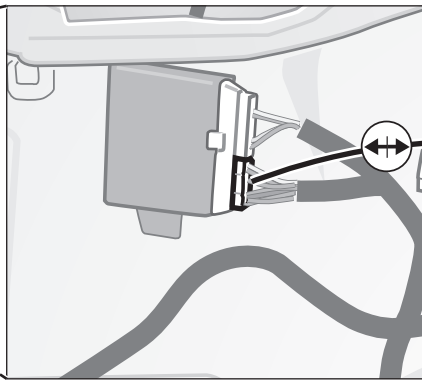
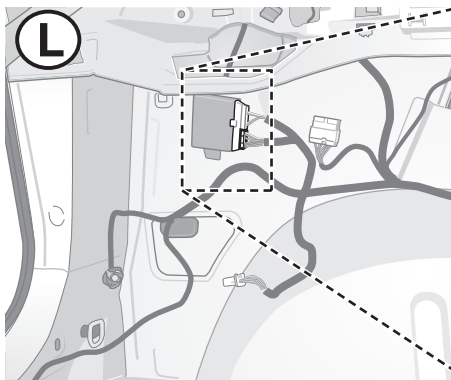

WT
24-pin

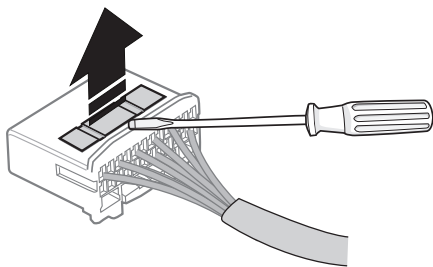

Otworzyć zabezpieczenie
Otvorit aretáciu!
Open secondary lock!

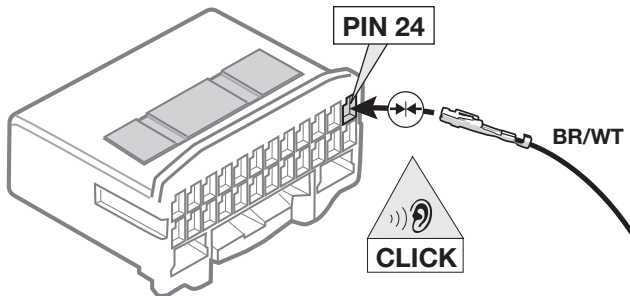

PIN 24

BR/WT

CLICK

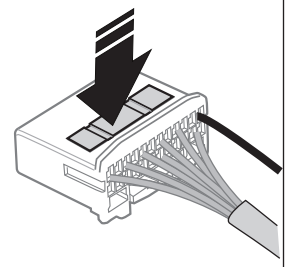

Zamknąć zabezpieczenie!
Uzavriet aretáciu!
Close secondary lock!





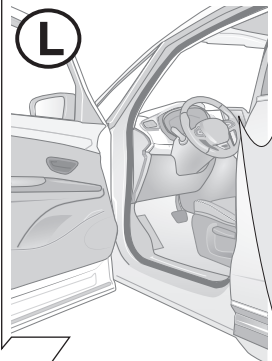

28

Kadjar  Samochody z czujnikami parkowania montowanymi fabrycznie!
Vozidla so seriovo montovanim parkovacim senzorum!
Vehicles with Factory-Fitted PDC-System!





L



 wóz	→	 System wspomagania parkowania	→	 wykrywania przeszkód	→	Wspomaganie parkowania z tyłu	ON	OFF
 Vehicle	→	 Park assist	→	 obstacle detection	→	Rear parking assistance	ON	OFF

29



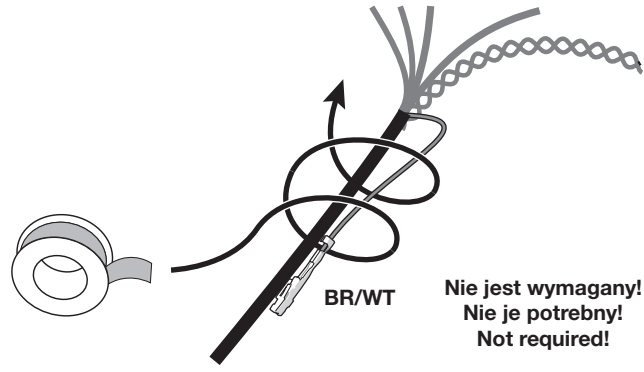







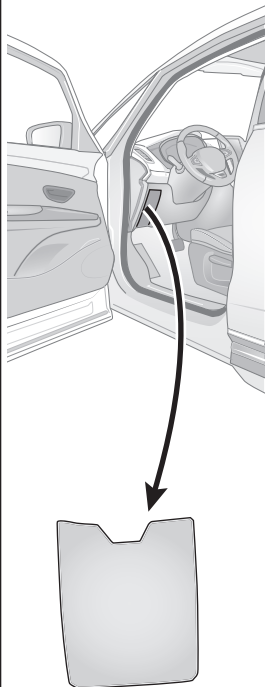
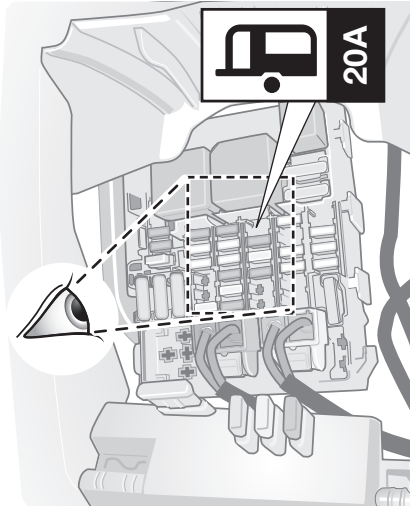
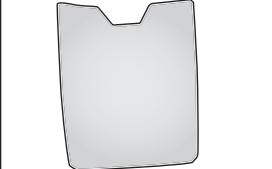
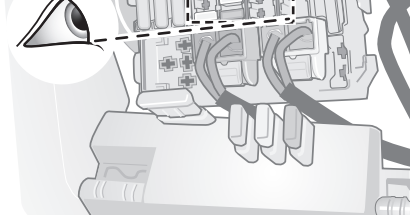























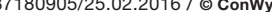





Espace	 Samochody bez czujników cofania Modely bez parkowacieho senzoru Vehicles without any PDC-System
Kadjar	 Samochody z czujnikami parkowania! Vozidla s parkovacim senzorum! Vehicles with PDC-System!
	 Samochody bez czujników cofania Modely bez parkowacieho senzoru Vehicles without any PDC-System



BR/WT

Nie jest wymagany!
Nie je potrebný!
Not required!

30

Espace	OPCJA 1	20A
L		
		
		
		
		
		
		
		
		
		
		
		
		
		
		
		
		
		
		
		
		
		

31

Kadjar

L

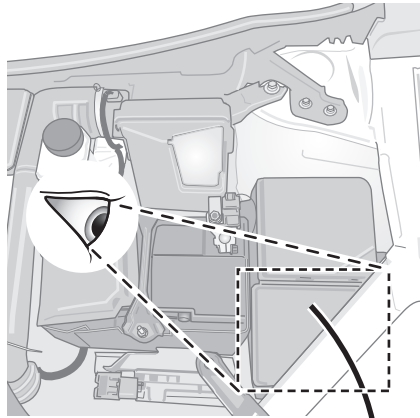
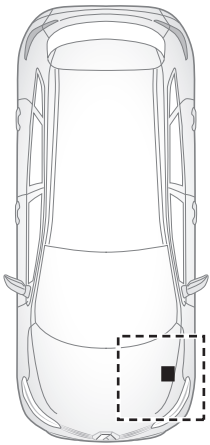

OPCJA 1

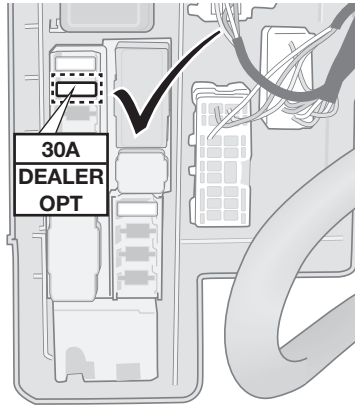

20A

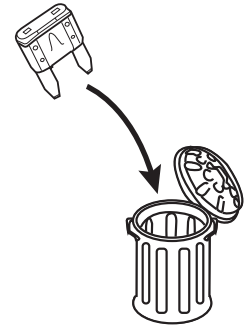

OPCJA 2

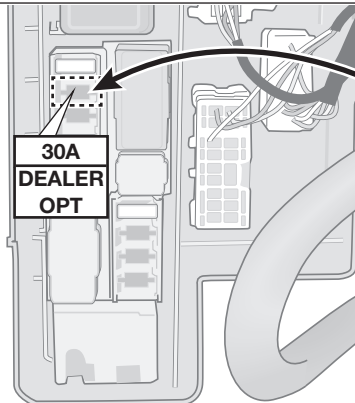

20A



32

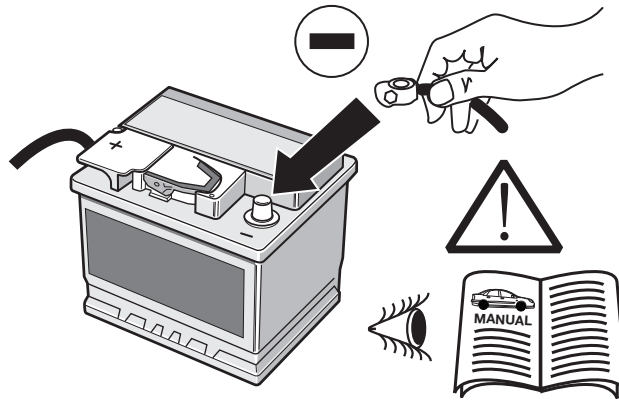

33

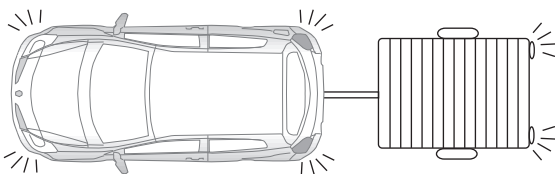
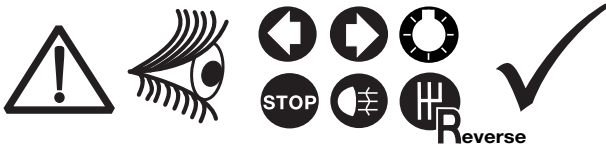

34

OPCJA

Symulacja przyczepek dla gniazd 7 i 13 Pinowych.

Simulator privesu pre 7- a 13-pol. zasovky.

Trailer Simulator for 7- and 13-pin Sockets

Art.
50400516

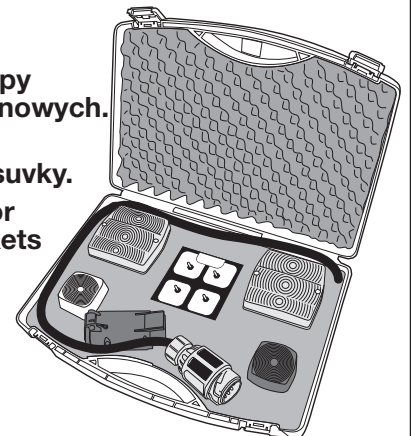

35

Opcja: Adapter 62400001
Optional: Adapter socket 62400001

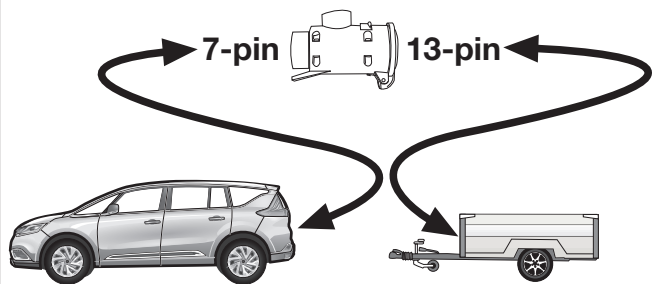

36

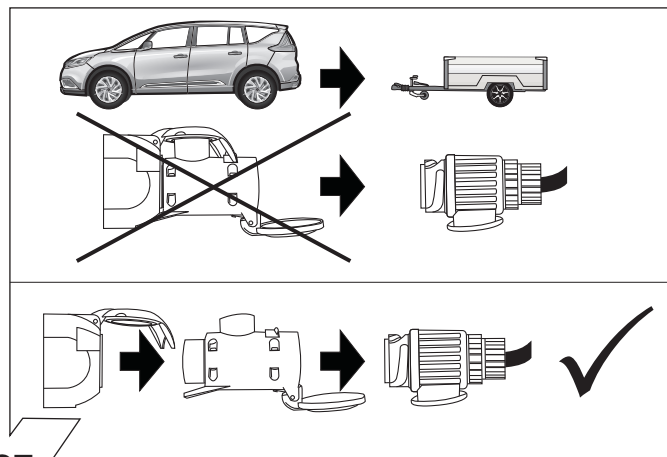

37

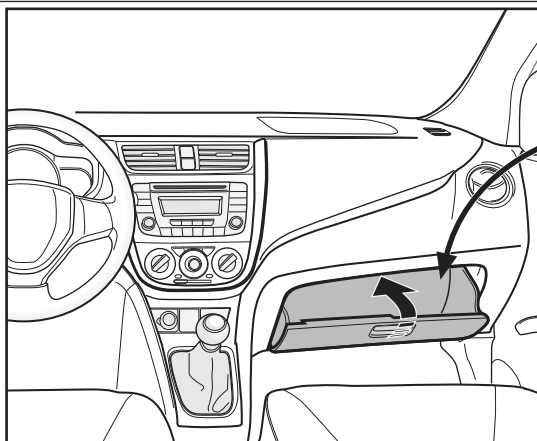

38

Aktywacja funkcji haka holowniczego / Aktivácia funkcie tazného zariadenia / Set up trailer operation

Space

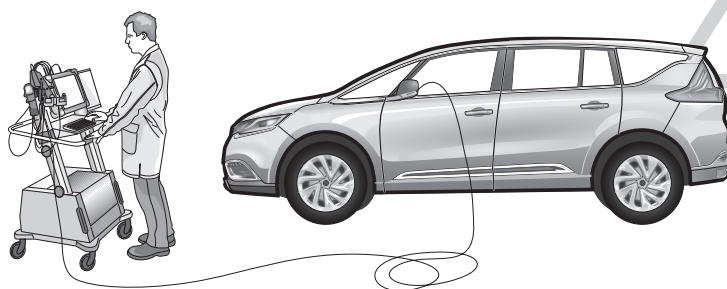

(PL)

Programowanie wykonać następująco:

1. uruchomić system diagnostyczny CLIP
2. zidentyfikować pojazd
3. Diagnostyka przyrząd sterowniczy
4. wybierać ABS
5. naprawa
6. Funkcja stabilizacji przyczepy > aktywować
7. pisanie konfiguracja

(SK)

Kódovanie vykonat nasledovne:

1. štartovať systém diagnostika CLIP
2. identifikovať vozidlo
3. diagnóza do riadiaca jednotka
4. vybrať ABS
5. oprava
6. Funkcia Trailer Stability Assist > Aktivovať
7. Písanie konfigurácia

(GB)

Please effect coding as follows:

1. Run Diagnostics System CLIP
2. identify vehicle
3. Diagnosis by controller
4. Select ABS
5. Repair
6. Function Trailer Stability Assist > activate
7. Writing of configuration

39

Kadjar

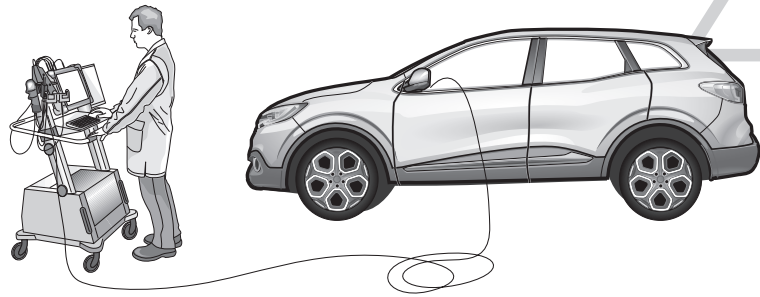

PL

Programowanie wykonać następująco:

1. uruchomić system diagnostyczny CLIP
2. zidentyfikować pojazd
3. Diagnostyka przyrząd sterowniczy
4. wybierać UCH (elektronika Central)
5. reperacja
6. Przyczepa dostępna > ze
7. potwierdzać

SK

Kódovanie vykonať nasledovne:

1. štartovať systém diagnostika CLIP
2. identifikovať vozidlo
3. diagnóza do riadiaca jednotka
4. vybrať UCH (Centrálna elektronika)
5. oprava
6. príves k dispozícii > so
7. potvrdiť

GB

Please effect coding as follows:

1. Run Diagnostics System CLIP
2. identify vehicle
3. Diagnosis by controller
4. Select UCH (central electronics)
5. Repair
6. trailer available > WITH
7. confirm

	Objasnienia symboli	Vysvetlivky k symbolom	Symbol explanation
	(PL)	(SK)	(GB)
	Lewe(58-L)lub prawe (58-R) koncowe swiatlo	Lavé (58-L) resp. prave (58-R) koncové svetlá	left (58-L) respectively right (58-R) tail light
	Swiatlo stop (54)/ trzecie swiatlo stop (54)	Brzdové svetlá (54)/ tretie brzdové svetlo (54)	stop light (54) / high mounted, third stop light (54)
	Kierunkowskaz lewy	Smerove svetlo lave	turn signal indicator left
	Kierunkowskaz prawy	Smerove svetlo prave	turn signal indicator right
	przeciwmgielne swiatlo	Hmlové svetlo(á)	rear fog light(s)
	swiatlo wsteczne	Spätné svetlo (á)	reversing light(s)
	staly plus/gniazdo 13 biegunowe, kontakt 9	Trvalé plus/zásuvka 13 polová, kontakt 9	Permanent power supply / 13pin socket, chamber 9
	przewód ladujcy/gniazdo 13 biegunowe, kontakt 10	Nabijací kábel/ zásuvka 13-polová, kontakt 10	charging wire for trailer fridge / 13pin socket, chamber 10
	przyczepa / rozpoznanie przyczepy	Príves / rozpoznanie prívesu	trailer / trailer recognition
	B+/30 staly plus/stale napiecie	Trvale plus/stály prúd prúdu	Permanent current power supply
	masa 31	Kostra (31)	Ground or Earth (31)
	klema baterii - minus	Pólová svorka batérie - minus	ground connection battery terminal lug
	klema baterii - plus	Pólová svorka batérie - plus	positive connection battery terminal lug
	Bezpiecznik/ ampera 20A	Poistka / Vykon poistky 20 Amper	fuse / fuse capacity 20 Ampere
	Zapalniczka / gniazdo uzupelniajace	Zapalovac / doplnková zásuvka	cigarette lighter / accessory socket
	klakson	Reproduktor / hukacka	loudspeaker / buzzer
	czujnik(sensor) parkowania	Parkovací senzor	park distance control
	Przelacznik	Prepinac / zdroj funkcie	switch / source of function
	polczyc	Spojít	Connect together
	rozlaczyc	Rozpojit	disconnect
	sledzic / patrz nastepne informacje	Sledovat / vid dalsie informacie	Look at / see further information
	sledzic/wybrana czesc	Sledovat vybranu oblast	look carefully at selected area
	znajdujacy sie w porzadku	Nachádzajúci sa / osadeny/v poriadku	Present / Occupied / OK
	nie znajdujacy sie / nie w porzadku	Nenachádzajúci sa/neosadeny/ nie v poriadku	Not present / Not occupied / not OK
	na lewo	Nalavo	left
	na prawo	Napravo	right
	dzwiekowa sygnalizacja	Zvuková signalizácia	acoustic indication
	Uwaga wazna informacja	Pozor dolezita informacia	attention / important advice